

# KRAMER



## USER MANUAL

**MODEL:**

**VP-440**

Presentation Switcher/Scaler



# VP-440 Quick Start Guide

This guide helps you install and use your product for the first time. For more detailed information, go to <http://www.kramerav.com/manual/VP-440> to download the latest manual or scan the QR code on the left.

## Step 1: Check what's in the box

- The VP-440 Presentation Switcher/Scaler
- 4 Rubber feet
- 1 Power cord
- 1 Quick start guide

## Step 2: Install the VP-440

Mount the machine in a rack or place on a table.

## Step 3: Connect inputs and outputs

Always switch OFF the power on each device before connecting it to your VP-440. For best results, we recommend that you always use Kramer high-performance cables to connect AV equipment to the VP-440.

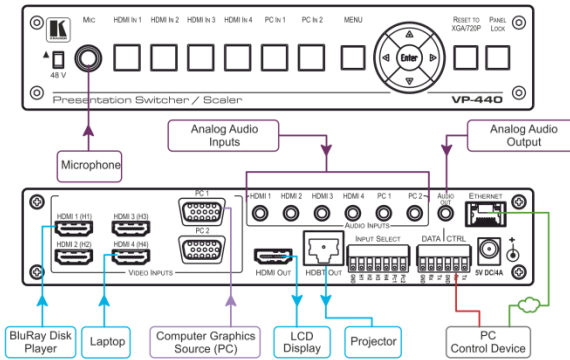

### RJ-45 Pinout

For the Ethernet and HDBaseT connectors, see the proper wiring diagram below:



EIA / TIA 568B	
PIN	Wire Color
1	Orange / White
2	Orange
3	Green / White
4	Blue
5	Blue / White
6	Green
7	Brown / White
8	Brown

For optimum range and performance use Kramer's BC-HDKat6a cable. This specially built cable significantly outperforms regular CAT 5/CAT 6 cables.

### The Microphone Pinout:

For a condenser microphone:

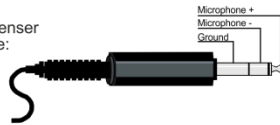

For a dynamic microphone:



## Step 4: Connect the power

Connect the 5V DC power adapter to the rear of the **VP-440** and connect the adapter to the mains electricity.

## Step 5: Set operation parameters via the OSD menu

Enter the OSD menu via the MENU button on the front panel. Select a menu item and set parameters as required.

If you cannot see any images, verify that the display, TV, or projector is in good working order, is connected to the **VP-440**, and that the **VP-440** is selected as its source. If you still don't see an image, press and hold the RESET TO XGA/720P button for 3 seconds to reset the output to XGA or 720p resolution.

Menu Item	Function
OUTPUT	Select the input, the image size and the resolution
PICTURE	Set the contrast, brightness, red, green and blue levels. Set the hue, saturation, sharpness, noise reduction. When PC is the selected input, finetune the image
AUDIO	Set the input and output volumes, the audio delay time and mute/unmute. Select the audio source for each HDMI input. Set the microphone mixer mode and the microphone volume
ADVANCED	Set HDCP on input and on output, auto sync off and the OSD parameters. Set the auto switch mode, the Ethernet parameters, and so on
FACTORY RESET	Perform factory reset
INFORMATION	Display the input and output resolutions, the HDCP status, the firmware version and the IP address

## Step 6: Operate via the front panel buttons and/or via the:

### Embedded Web Page:

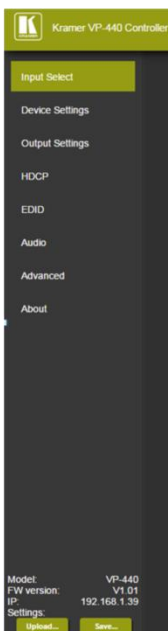

### RS-232 and Ethernet:

RS-232	
Baud Rate:	9,600
Data Bits:	8
Stop Bits:	1
Parity:	None
Ethernet	
To reset the IP settings to the factory reset values go to : Menu-> Factory-> RESET->Change the option to YES and press Enter	
IP Address:	192.168.1.39
Subnet mask:	255.255.0.0
Default gateway:	0.0.0.0
Default UDP Port #:	50000
Maximum UDP Ports:	4
Full Factory Reset	
OSD	Go to : Menu-> Factory-> RESET->Change the option to YES and press Enter
RS-232/Ethernet (UDP) Command Protocol	
Command Format:	ASCII protocol 3000
Example (Route the video HDMI3 input to the output):	#ROUTE 12,1,2<cr>

# Contents

<b>1</b>	<b>Introduction</b>	<b>1</b>
<b>2</b>	<b>Getting Started</b>	<b>2</b>
2.1	Achieving the Best Performance	2
2.2	Safety Instructions	3
2.3	Recycling Kramer Products	3
<b>3</b>	<b>Overview</b>	<b>4</b>
3.1	Using Twisted Pair Cable for HDBT	5
3.2	Defining the VP-440 Presentation Switcher/Scaler	6
<b>4</b>	<b>Connecting the VP-440</b>	<b>8</b>
4.1	Microphone Pinout	10
4.2	Wiring the TP LINE OUT RJ-45 Connector	11
<b>5</b>	<b>Controlling the VP-440</b>	<b>12</b>
5.1	Controlling via the Front Panel Buttons	12
5.2	Using the OSD Menu	12
5.3	Connecting to the VP-440 via RS-232	15
5.4	Operating via Ethernet	16
5.5	Controlling the VP-440 via the REMOTE Terminal Block Connector	20
<b>6</b>	<b>Using the Embedded Web Pages</b>	<b>21</b>
6.1	Browsing the VP-440 Web Pages	21
6.2	The Input Select Page	22
6.3	The Device Settings Page	25
6.4	The Output Settings Page	27
6.5	The HDCP Page	28
6.6	The EDID Page	29
6.7	The Audio Settings Page	31
6.8	The Advanced Page	31
6.9	The About Page	32
<b>7</b>	<b>Technical Specifications</b>	<b>33</b>
7.1	Default Communication Parameters	34
7.2	Input Resolutions	34
<b>8</b>	<b>The RS-232/Ethernet (UDP) Communication Protocol</b>	<b>35</b>
8.1	Kramer Protocol 3000 Syntax	35
8.2	Kramer Protocol 3000 – Command List	38
8.3	Kramer Protocol 3000 – Detailed Commands	39

# Figures

Figure 1: VP-440 Presentation Switcher/Scaler Front Panel	6
Figure 2: VP-440 Presentation Switcher/Scaler Rear Panel	7
Figure 3: Connecting the VP-440 Presentation Switcher / Scaler	9
Figure 4: Condenser Microphone Pinout	10
Figure 5: Dynamic Microphone Pinout	10
Figure 6: TP PINOUT	11
Figure 7: RS-232 Pinout	16
Figure 8: Local Area Connection Properties Window	17
Figure 9: Internet Protocol Version 4 Properties Window	18
Figure 10: Internet Protocol Version 6 Properties Window	18
Figure 11: Internet Protocol Properties Window	19
Figure 12: Connecting the Contact Closure Remote Control PINs	20
Figure 13: The Input Select Page	23
Figure 14: The VP-440 Standby Mode	23
Figure 15: The Input Select Page – Mixer On/Off	24
Figure 16: The Input Select Page – Edit Input Buttons (HDMI and VGA Respectively)	24
Figure 17: The Device Settings Page	25
Figure 18: The Device Settings Page – Static IP Confirmation	25
Figure 19: The Device Settings Page – Uploading the New Firmware File	26
Figure 20: The Device Settings Page – Uploading the New Firmware File	26
Figure 21: The Device Settings Page – New Firmware Updated	26
Figure 22: The Output Settings Page	27
Figure 23: The HDCP Page	28
Figure 24: The EDID Page	29
Figure 25: The EDID Page – Copying a Resolution	30
Figure 26: The EDID Page –The Copy EDID Results	30
Figure 27: The Audio Settings Page	31
Figure 28: The Advanced Page	32
Figure 29: The About Page	32

---

# 1 Introduction

Welcome to Kramer Electronics! Since 1981, Kramer Electronics has been providing a world of unique, creative, and affordable solutions to the vast range of problems that confront video, audio, presentation, and broadcasting professionals on a daily basis. In recent years, we have redesigned and upgraded most of our line, making the best even better!

Our 1,000-plus different models now appear in 14 groups that are clearly defined by function: GROUP 1: Distribution Amplifiers; GROUP 2: Switchers and Routers; GROUP 3: Control Systems; GROUP 4: Format/Standards Converters; GROUP 5: Range Extenders and Repeaters; GROUP 6: Specialty AV Products; GROUP 7: Scan Converters and Scalers; GROUP 8: Cables and Connectors; GROUP 9: Room Connectivity; GROUP 10: Accessories and Rack Adapters; GROUP 11: Sierra Video Products; GROUP 12: Digital Signage; GROUP 13: Audio; and GROUP 14: Collaboration.

Congratulations on purchasing your Kramer **VP-440** Presentation Switcher/Scaler. This product, which incorporates HDMI™ technology, is ideal for:

- Classroom, lecture theaters and education application
- Projection systems in conference rooms, boardrooms, hotels and churches

---

## 2 Getting Started

We recommend that you:

- Unpack the equipment carefully and save the original box and packaging materials for possible future shipment
- Review the contents of this user manual



Go to <http://www.kramerav.com/downloads/VP-440> to check for up-to-date user manuals, application programs, and to check if firmware upgrades are available (where appropriate).

### 2.1 Achieving the Best Performance

To achieve the best performance:

- Use only good quality connection cables (we recommend Kramer high-performance, high-resolution cables) to avoid interference, deterioration in signal quality due to poor matching, and elevated noise levels (often associated with low quality cables)
- Do not secure the cables in tight bundles or roll the slack into tight coils
- Avoid interference from neighboring electrical appliances that may adversely influence signal quality
- Position your Kramer **VP-440** away from moisture, excessive sunlight and dust



This equipment is to be used only inside a building. It may only be connected to other equipment that is installed inside a building.

## 2.2 Safety Instructions



**Caution:** There are no operator serviceable parts inside the unit

**Warning:** Use only the Kramer Electronics power supply that is provided with the unit

**Warning:** Disconnect the power and unplug the unit from the wall before installing

## 2.3 Recycling Kramer Products

The Waste Electrical and Electronic Equipment (WEEE) Directive 2002/96/EC aims to reduce the amount of WEEE sent for disposal to landfill or incineration by requiring it to be collected and recycled. To comply with the WEEE Directive, Kramer Electronics has made arrangements with the European Advanced Recycling Network (EARN) and will cover any costs of treatment, recycling and recovery of waste Kramer Electronics branded equipment on arrival at the EARN facility. For details of Kramer's recycling arrangements in your particular country go to our recycling pages at <http://www.kramerelectronics.com/support/recycling/>.



---

## 3 Overview

The **VP-440** is a high-performance presentation scaler/switcher for HDMI and computer graphics signals. The unit scales the video, embeds the audio, and outputs the signal to both an HDMI and an HDBaseT output, as well as outputting to unbalanced stereo audio.

The **VP-440** features:

- PixPerfect™ scaling technology – Kramer’s precision pixel mapping and high quality scaling technology, with full up and down scaling of all video input signals
- HDTV compatibility
- HDCP compliance
- 6 video inputs - 4 HDMI on HDMI connectors, 2 computer graphics video on 15-pin HD connectors
- Scaled output on HDMI and HDBT connectors simultaneously
- System Range for the HDBT inputs and outputs - Up to 70m (230ft)



For optimum range and performance using HDBaseT™, use Kramer’s **BC-HDKat6a** cable. Note that the transmission range depends on the signal resolution, source and display used. The distance using non-Kramer CAT 6 cable may not reach these ranges.

- Up to UXGA/1080p output resolutions
- Microphone input with audio DSP options including mixing and talk-over
- Companion AFV (Audio-Follow-Video) – stereo audio for every video input
- 6 unbalanced stereo inputs on 3.5mm connectors as well as embedded audio for the HDMI inputs, each with individual level controls
- Audio outputs – one unbalanced stereo on a 3.5mm connector as well as embedded audio on the HDMI and HDBT outputs
- Multiple aspect ratio selections - full, best fit, over scan, under scan, letter box and pan scan

- Powerful audio features via DSP technology including audio equalization, mixing, delay and so on
- Built-in ProcAmp - color, hue, sharpness, noise, contrast and brightness
- Supports 4:4:4 (RGB and YUV) as well as 4:2:2 (YUV) color sampling in Native mode
- Maintains constant output sync – there is no disruption on the output while switching between inputs and when no video is detected
- Dedicated RS-232 port for bidirectional data tunneling via HDBT
- Front panel lockout
- Non-volatile memory – saves final settings

Control your **VP-440**:

- Directly, via the front panel push buttons
- By RS-232 serial commands transmitted by a touch screen system, PC, or other serial controller
- Via the OSD (on-screen display)
- Via remote contact-closure switches
- Via the Ethernet with built-in Web pages

The **VP-440** is housed in a 1/2 19" 1U enclosure, letting 2 units to be rack mounted side-by-side in a 1U rack space with the optional **RK-1** universal rack adapter.

### 3.1 Using Twisted Pair Cable for HDBT

Kramer engineers have developed special twisted pair cables to best match our digital twisted pair products; **BC-HDKat6a** (CAT 6 23 AWG cable) significantly outperforms regular CAT 5 / CAT 6 cables.



We strongly recommend that you use shielded twisted pair cable.

### 3.2 Defining the VP-440 Presentation Switcher/Scaler

This section defines the **VP-440**.

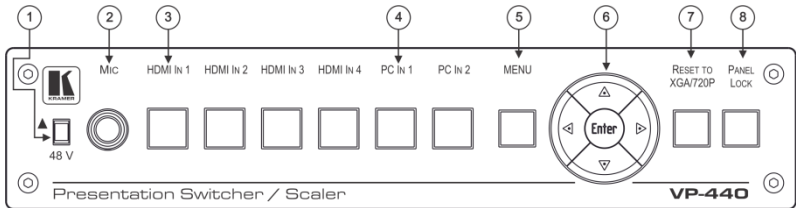

Figure 1: VP-440 Presentation Switcher/Scaler Front Panel

#	Feature	Function	
1	▲ / 48 V	Move up (48V) to select a condenser type microphone; down to select a dynamic type microphone. (We recommend keeping the switch down if a microphone is not connected to the <b>VP-440</b> )	
2	MIC 6.3mm Jack	Connect to the microphone source	
3	Input Selector Buttons	HDMI IN	Press to select the HDMI input (from 1 to 4)
		PC IN	Press to select the computer graphics input (from 1 to 2)
4	MENU Button	Displays the OSD menu (see <a href="#">Section 5.2</a> )	
6	Navigation Buttons	◀	Press to decrease numerical values or select from several definitions When not within the OSD menu mode, press to reduce the output volume
		▲	Press to move up the menu list values (see <a href="#">Section 5.2</a> )
		▶	Press to increase numerical values or select from several definitions When not within the OSD menu mode, press to increase the output volume
		▼	Press to move down the menu list (see <a href="#">Section 5.2</a> )
		ENTER	Press to accept changes and change the SETUP parameters (see <a href="#">Section 5.2</a> )
7	RESET TO XGA/720p Button	Press to reset the video resolution to XGA or 720p Press and hold for about 5 seconds to toggle between switching to XGA or 720p	
8	PANEL LOCK Button	Press and hold for about 5 seconds to lock/unlock the front panel buttons	

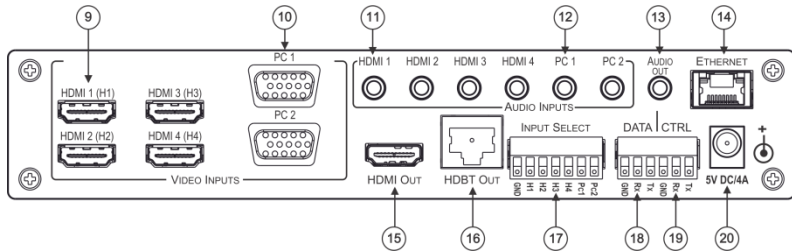

Figure 2: VP-440 Presentation Switcher/Scaler Rear Panel

#	Feature	Function
9	VIDEO INPUT Connectors	HDMI Connect to the HDMI source (from 1 to 4)
10	PC 15-pin HD	Connect to the computer graphics source (from 1 to 2)
11	AUDIO INPUT	HDMI Connect to the analog audio HDMI source (from 1 to 4)
12	Unbalanced Stereo 3.5 Mini Jack Connector	PC Connect to the analog audio computer graphics source (from 1 to 2)
13	AUDIO OUT 3.5 Mini Jack Connector	Connect to a an unbalanced stereo audio acceptor
14	ETHERNET Connector	Connects to the PC or other controller through computer networking
15	HDMI OUT	Connect to the HDMI acceptor
16	HDBT RJ-45	Connect to an HDBT Receiver (for example, the Kramer <b>TP-580Rxr</b> )
17	INPUT SELECT Terminal Block Connectors	For remotely switching the inputs via contact closure switches
18	DATA (Tx, Rx, GND) Terminal Block Connectors	Connect to the PC or control device to tunnel data between this RS-232 port and the HDBT OUT port
19	CTRL (Tx, Rx, GND) Terminal Block Connectors	Connect to the PC or the serial controller
20	5V DC/4A	+5V DC connector for powering the unit

---

## 4 Connecting the VP-440



Always switch off the power to each device before connecting it to your **VP-440**. After connecting your **VP-440**, connect its power and then switch on the power to each device.



You do not have to connect all the inputs and outputs, connect only those that are required.

To connect the **VP-440**, as illustrated in the example in [Figure 3](#), do the following:

1. Connect an HDMI source (for example, a BluRay disk player) to the HDMI 1 (H1) VIDEO INPUT connector (from 1 to 4).  
Alternatively, you can connect the DVI connector on the DVD player to the HDMI connector on the **VP-440** via a DVI-HDMI adapter. When using this adapter, you can connect the audio signal via the terminal block connector
2. Connect a computer graphics source to the PC 1 15-pin HD VIDEO INPUT connector (from 1 to 2).
3. Connect the audio input signals to the AUDIO INPUT 3.5mm mini jack connectors, as required (not shown in [Figure 3](#)).
4. Connect the HDMI OUT connector to an HDMI acceptor (for example, an LCD display).
5. Connect the HDBT OUT connector to an HDBT receiver (for example, the output of **TP-580R** connected to HDBT).
6. Connect the AUDIO OUT 3.5mm mini jack connector to an unbalanced stereo audio acceptor (not shown in [Figure 3](#)).
7. On the front panel, connect a microphone to the MIC 6.5mm phone jack and set it to condenser or dynamic type.
8. Connect the power cord (not shown in [Figure 3](#)).

9. Connect the:
  - RS-232 DATA 3-pin terminal block connector (Tx, Rx, G) to a PC for sending RS-232 commands via HDBT
  - RS-232 CONTROL 3-pin terminal block connector (Tx, Rx, G) to a PC to control the unit
10. Connect the INPUT SELECT 7-pin terminal block contact-closure remote-control pins to select an input by momentarily pressing the switch.
11. Connect the ETHERNET port, see [Section 5.4](#)

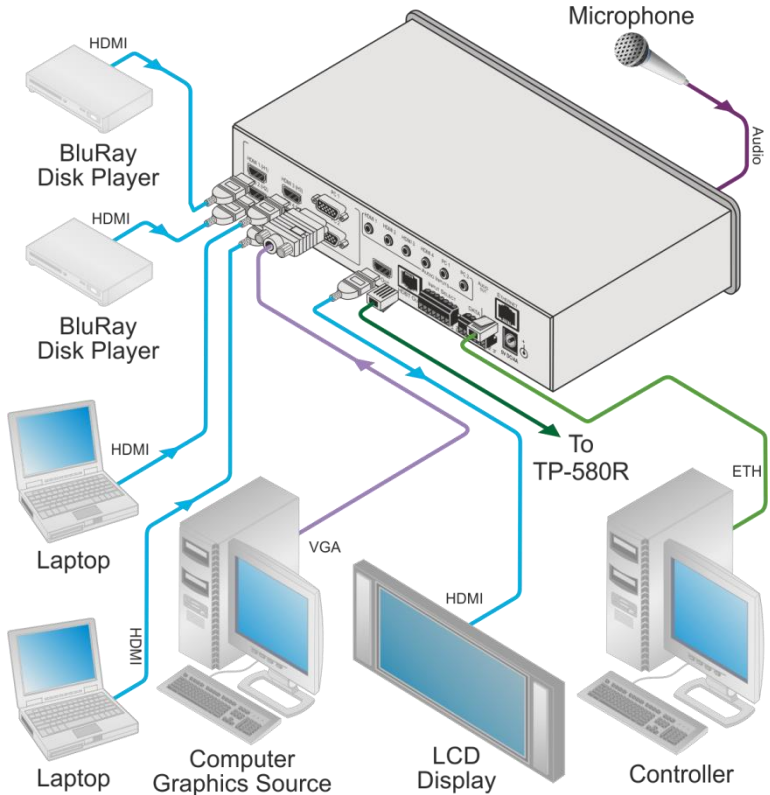

Figure 3: Connecting the VP-440 Presentation Switcher / Scaler

## 4.1 Microphone Pinout

The microphone  
6.3mm jack pinout for a  
condenser microphone.

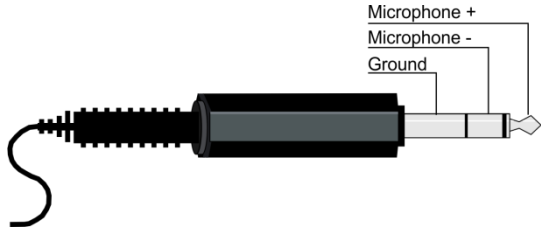

Figure 4: Condenser Microphone Pinout

The microphone  
6.3mm jack pinout for a  
Dynamic microphone.

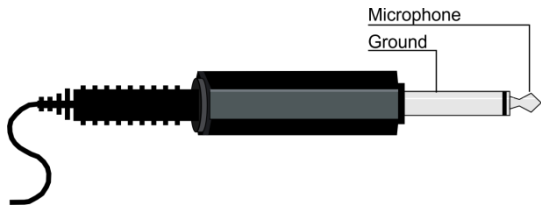

Figure 5: Dynamic Microphone Pinout

## 4.2 Wiring the TP LINE OUT RJ-45 Connector

This section defines the TP pinout, using a **straight** pin-to-pin cable with RJ-45 connectors.

EIA / TIA 568B	
PIN	Wire Color
1	Orange / White
2	Orange
3	Green / White
4	Blue
5	Blue / White
6	Green
7	Brown / White
8	Brown

Figure 6: TP PINOUT

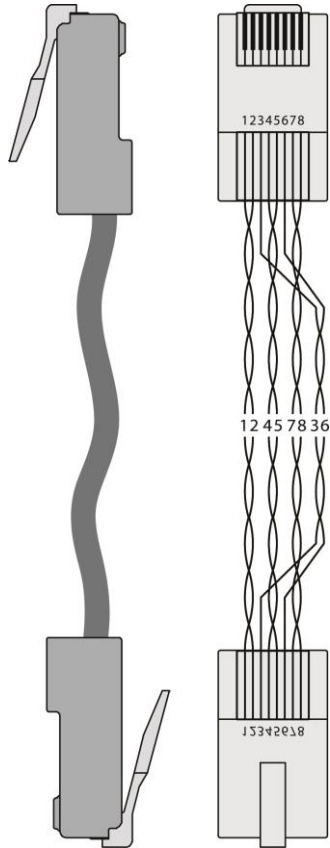



---

## 5 Controlling the VP-440

The **VP-440** can be controlled via:

- The front panel buttons (see [Section 5.1](#))
- The OSD menu (see [Section 5.2](#))
- RS-232 port (see [Section 5.3](#))
- The ETHERNET (see [Section 5.4](#))
- Remote control contact closure (see [Section 5.5](#))

### 5.1 Controlling via the Front Panel Buttons

The **VP-440** includes the following front panel buttons:

- Input selector buttons for selecting the required input: HDMI (1 to 4) and PC (1 and 2)
- MENU, ENTER, and up, down, left and right arrow buttons
- RESET TO XGA/720p and PANEL LOCK buttons

#### 5.1.1 The Auto Adjust Feature

The auto adjust feature may be implemented every time the input is switched to VGA or when the input resolution changes, as set in the FINETUNE menu (see [Section 5.2.1](#)).

### 5.2 Using the OSD Menu

The control buttons let you control the **VP-440** via the OSD menu. Press the:

- MENU button to enter the menu  
The default timeout is set to 10 seconds
- ENTER button to accept changes and to change the menu settings
- Arrow buttons to move through the OSD menu, which is displayed on the video output

On the OSD menu, select EXIT to exit the menu.

## 5.2.1 The MAIN MENU

Mode	Function			
<b>OUTPUT</b>				
SOURCE:	Select the input: HDMI 1, HDMI 2, HDMI 3, HDMI 4, PC1 or PC2			
SIZE:	Select the image size: FULL, OVER SCAN, UNDER 1, UNDER 2, LETTER BOX, PAN SCAN or BEST FIT			
RESOLUTION:	Select the output resolution from the menu:			
	Output resolution:	Appears as:	Output resolution:	Appears as:
	NATIVE OUT1		1680x1050 @60Hz	1680x1050 60
	NATIVE OUT2		1600x1200 @60Hz	1600x1200 60
	640x480 @60Hz	640x480 60	1920x1080 @60Hz	1920x1080 60
	800x600 @60Hz	800x600 60	1920x1200 @60Hz	1920x1200 60
	1024x768 @60Hz	1024x768 60	480p @60Hz	720x480P 60
	1280x768 @60Hz	1280x768 60	720p @60Hz	1280x720P 60
	1360x768 @60Hz	1360x768 60	1080i @60Hz	1920x1080I 60
	1280x720 @60Hz	1280x720 60	1080p @60Hz	1920x1080P 60
	1280x800 @60Hz	1280x800 60	576p @50Hz	720x576P 50
	1280x1024 @60Hz	1280x1024 60	720p @50Hz	1280x720P 50
	1440x900 @60Hz	1440x900 60	1080i @50Hz	1920x1080I 50
	1400x1050 @60Hz	1400x1050 60	1080p @50Hz	1920x1080P 50
	<b>NATIVE</b> - Select NATIVE to select the output resolution from the EDID of the connected HDMI monitor			
<b>PICTURE</b>				
CONTRAST:	Set the contrast (the range and default values vary according to the input signal)			
BRIGHTNESS:	Set the brightness (the range and default values vary according to the input signal)			
RED	Set the red level			
GREEN	Set the green level			
BLUE	Set the blue level			
HUE	Set the color hue (not applicable for VGA inputs)			
SATURATION	Set the color saturation (not applicable for VGA inputs)			
SHARPNESS	Set the sharpness of the picture (not applicable for VGA inputs)			
NOISE REDUCTION	Select the noise reduction: OFF, LOW, MID (middle) and HIGH (not applicable for VGA inputs)			
FINETUNE	Enabled for VGA: AUTO ADJUST (NO/YES), H-POSITION, V-POSITION, PHASE, CLOCK, WXGA/XGA, RESET (NO/YES)			
<b>AUDIO</b>				
INPUT VOLUME:	Set the volume separately for each input: HDMI 1, HDMI 2, HDMI 3, HDMI 4, PC1 and PC2			
OUTPUT VOLUME:	Set the output volume			
DELAY	Select the audio delay time: OFF, 40ms, 110ms and 150ms			
MUTE	Select the sound mute options: ON or OFF			
EMBEDDED AUDIO:	Select the audio source of the HDMI 1 to HDMI 4 inputs: <b>AUTOMATIC:</b> the embedded audio on the HDMI input is selected for an HDMI signal, or the analog audio input is selected if the input is not HDMI			

Mode	Function	
	(for example, for a DVI input signal) <b>EMBEDDED:</b> the embedded audio in the HDMI signal is selected <b>ANALOG:</b> the analog audio input is selected	
MIC SETTINGS	<p><b>MIC MODE</b> - set the mode to OFF, MIXER, TALKOVER or MIC ONLY. When in <b>TALKOVER</b> mode, set the:</p> <p><b>DEPTH</b> [%] – to determine the decrease of the audio level during microphone 1 takeover (press + to further decrease the talkover audio output level; press – to lessen the talkover output audio decrease level)</p> <p><b>TRIGGER</b> [dB] – to determine the microphone threshold level that triggers the audio output-level decrease.</p> <p><b>ATTACK TIME</b> – to set the transition time of the audio level reduction after the signal rises above the threshold level</p> <p><b>HOLD TIME</b> – to define the time period talkover remains active although the signal falls below the threshold level (for a short period of time)</p> <p><b>RELEASE TIME</b> – to define the transition time for the audio level to return from its reduced level to its normal level after the Hold Time period</p>	
MIC VOLUME	Set the microphone volume for MIC	
DRC	Dynamic Range Compression – allows a dynamic volume range. Set to ON to dynamically create a sound range according to the volume level. For example, in a movie the volume will be high enough to hear the dialogues and at the same time loud explosions and sudden noises in the soundtrack will be toned down so others would not be disturbed.	
<b>ADVANCED</b>		
HDCP ON INPUT	Select the HDCP option for the HDMI inputs (1 to 4): either ON (the default) or OFF. Setting HDCP support to disabled (OFF) on the HDMI input allows the source to transmit a non-HDCP signal if required (for example, when working with a Mac computer)	
HDCP ON OUTPUT	<p>Set HDMI OUT and HDBT OUT: Select FOLLOW INPUT or FOLLOW OUTPUT to define whether the HDCP will follow the input or the output</p> <p>When FOLLOW INPUT is selected, it changes its HDCP output setting (for the HDMI output) according to the HDCP of the input. This option is recommended when the HDMI/HDCP output is connected to a splitter/switcher</p> <p>When FOLLOW OUTPUT is selected, the scaler matches its HDCP output to the HDCP setting of the HDMI/HDCP acceptor to which it is connected</p>	
AUTO SYNC OFF	Turn to OFF (disable the AUTO SYNC OFF feature), FAST (for almost immediate shut down if no input is present – about 10 seconds) or SLOW (for shutdown after about 2 minutes). This is useful, for example, when the output is connected to a projector, and the projector will automatically shut down when it has no input	
OSD	H POSITION	Set the horizontal position of the OSD
	V POSITION	Set the vertical position of the OSD
	TIMER	Set the timeout period in seconds
	TRANSPARENCY	Set the OSD background between 100 (transparent) and 0 (opaque)
	DISPLAY	<p>Select the information shown on the screen during operation:</p> <p><b>INFO:</b> the information is shown for 10 seconds</p> <p><b>ON:</b> the information is shown permanently</p> <p><b>OFF:</b> the information is not shown</p>

Mode	Function	
AUTO SWITCHING	MODE	Set the auto switching mode to OFF, AUTO SCAN or LAST CONNECTED. SCAN PRIORITY (below) is enabled when AUTO SCAN is selected When one of the auto switching modes is selected (AUTO SCAN or LAST CONNECTED), audio is enabled only when a video signal is detected
	SCAN PRIORITY	Set to HDMI to begin scanning with HDMI1 or to PC to begin scanning with PC1
ETHERNET	IP MODE	Set the IP mode to DHCP or STATIC
	STATIC IP ADDRESS (fill in if STATIC (above) is selected):	
	IP ADDRESS	Enter the IP address
	SUBNET	Enter the subnet
	GATEWAY	Enter the gateway
	CONTROL PORT	Enter the control port
	MAC ADDRESS	MAC address
LOCK MODE	ALL	Lock all the front panel buttons
	MENU ONLY	Lock the MENU (and navigation) front panel buttons only
	ALL & SAVE	Lock all the front panel buttons. The lock status is saved when the <b>VP-440</b> is powered down
	MENU ONLY AND SAVE	Lock the MENU (and navigation) front panel buttons only. The lock status is saved when the <b>VP-440</b> is powered down
TIMING SHIFT	Set to ON (recommended): Implements a small shift on the horizontal sync to improve output picture stability. Set to OFF if the display shows an instability at the selected output resolution	
<b>FACTORY RESET</b>		
	Select NO or YES	
<b>INFORMATION</b>		
	Displays the INPUT and OUTPUT resolutions, INPUT and OUTPUT HDCP status, the IP ADDRESS and the FIRMWARE revision number	

## 5.3 Connecting to the VP-440 via RS-232

The **VP-440** features two RS-232 ports:

- RS-232 DATA (Tx, Rx, GND) to pass data to and from the machine that is connected to the HDBT connector
- RS-232 CTRL (Tx, Rx, GND) to control the **VP-440**

To connect to the **VP-440** via RS-232 connect the RS-232 Terminal block connector on the product to the RS-232 9-pin D-sub port on your PC/controlled device:

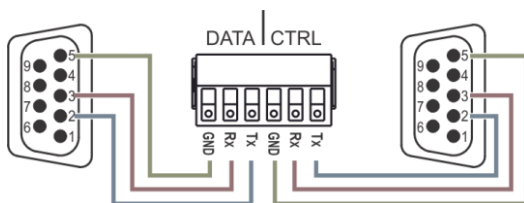

Figure 7: RS-232 Pinout

Connect this PIN on the terminal block connector	To this PIN on the 9-pin D-sub Connector
Tx	PIN 2
Rx	PIN 3
GND	PIN 5

## 5.4 Operating via Ethernet

You can connect to the **VP-440** via Ethernet using either of the following methods:

- Directly to the PC using a crossover cable (see [Section 5.4.1](#))
- Via a network hub, switch, or router, using a straight-through cable (see [Section 5.4.2](#))

**Note:** If you want to connect via a router and your IT system is based on IPv6, speak to your IT department for specific installation instructions.

### 5.4.1 Connecting the Ethernet Port Directly to a PC

You can connect the Ethernet port of the **VP-440** directly to the Ethernet port on your PC using a crossover cable with RJ-45 connectors.



This type of connection is recommended for identifying the **VP-440** with the factory configured default IP address.

After connecting the **VP-440** to the Ethernet port, configure your PC as follows:

1. Click **Start > Control Panel > Network and Sharing Center**.
2. Click **Change Adapter Settings**.
3. Highlight the network adapter you want to use to connect to the device and click **Change settings of this connection**.

The Local Area Connection Properties window for the selected network adapter appears as shown in [Figure 8](#).

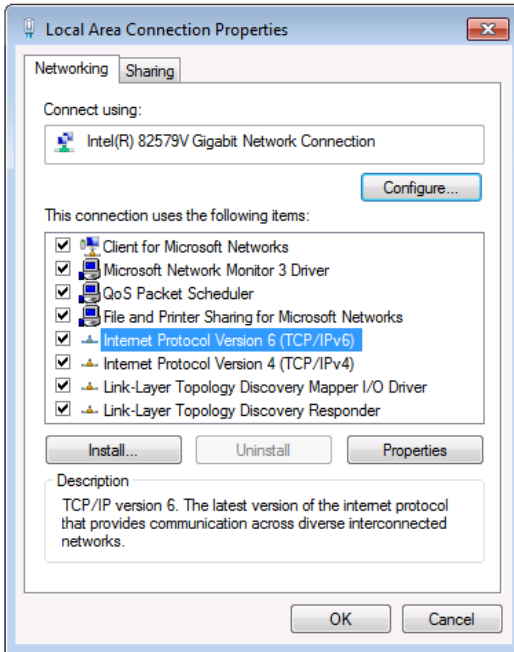

Figure 8: Local Area Connection Properties Window

4. Highlight either **Internet Protocol Version 6 (TCP/IPv6)** or **Internet Protocol Version 4 (TCP/IPv4)** depending on the requirements of your IT system.
5. Click **Properties**.

The Internet Protocol Properties window relevant to your IT system appears as shown in [Figure 9](#) or [Figure 10](#).

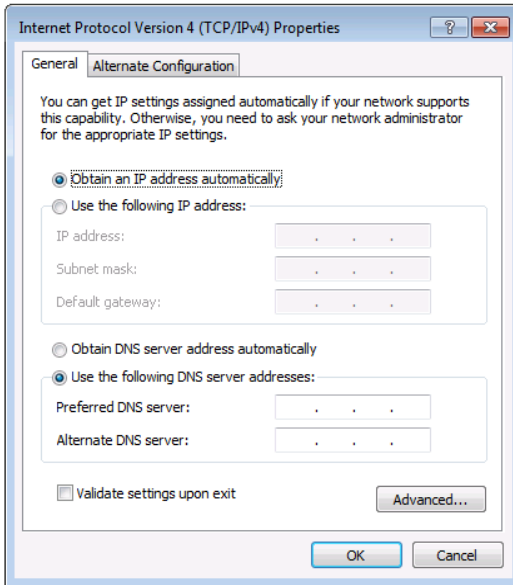

Figure 9: Internet Protocol Version 4 Properties Window

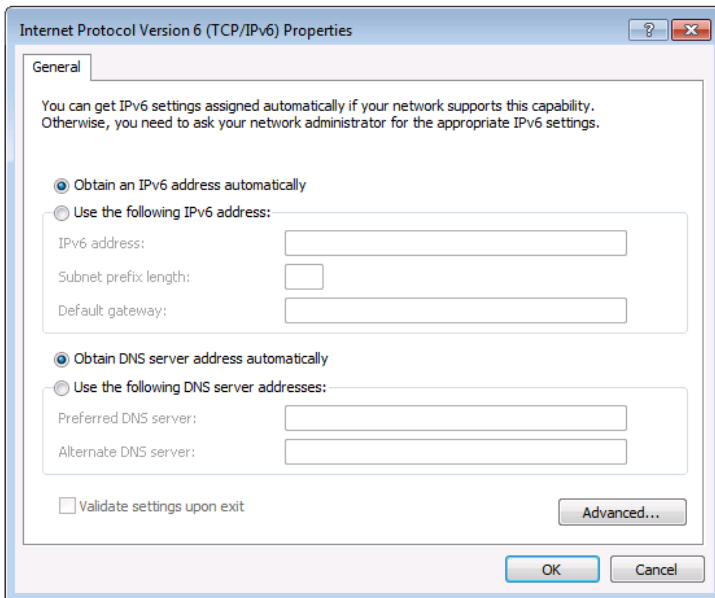

Figure 10: Internet Protocol Version 6 Properties Window

6. Select **Use the following IP Address** for static IP addressing and fill in the details as shown in [Figure 11](#).

For TCP/IPv4 you can use any IP address in the range 192.168.1.1 to 192.168.1.255 (excluding 192.168.1.39) that is provided by your IT department.

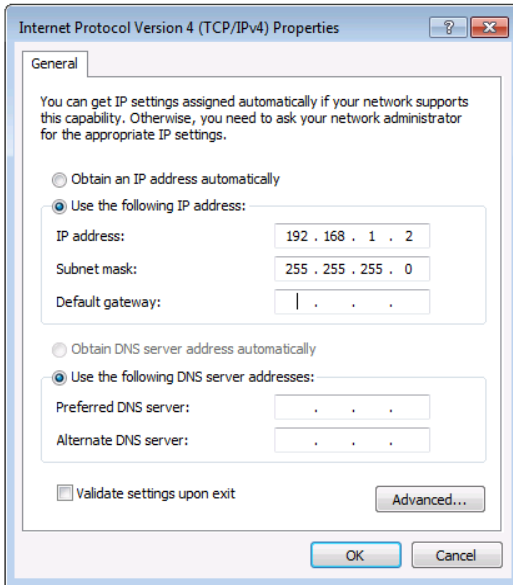

Figure 11: Internet Protocol Properties Window

7. Click **OK**.
8. Click **Close**.

#### 5.4.2 Connecting the Ethernet Port via a Network Hub or Switch

You can connect the Ethernet port of the **VP-440** to the Ethernet port on a network hub or using a straight-through cable with RJ-45 connectors.

#### 5.4.3 Configuring the Ethernet Port

You can set the Ethernet parameters via the embedded Web pages (see [Section 6](#)).



## 5.5 Controlling the VP-440 via the REMOTE Terminal Block Connector

The REMOTE terminal block connectors include six input pins (H1 to H4 and PC1 to PC2) and a G pin for selecting an input.

The contact closure remote control pins operate in a similar way to the INPUT buttons (see [Section 5.1](#)). Using the contact closure remote control (also known as push-to-make momentary contact) you can select any of the inputs. To do so, momentarily connect the required input pin on the INPUT SELECT terminal block connector to the G (Ground) pin of the REMOTE terminal block connector, as [Figure 12](#) illustrates.



**Do not** connect more than one input PIN to the GND PIN at the same time.

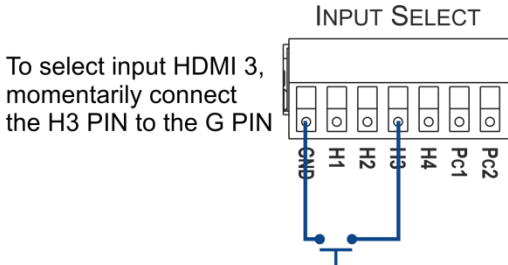

Figure 12: Connecting the Contact Closure Remote Control PINs

---

## 6 Using the Embedded Web Pages

The **VP-440** can be operated remotely using the embedded Web pages. The Web pages are accessed using a Web browser and an Ethernet connection.

Before attempting to connect:

- Perform the procedures in [Section 5.4](#).
- Ensure that your browser is supported

The following operating systems and Web browsers are supported:

Operating Systems	Applicable Browser Versions and Higher
Windows 7	Chrome: 25 Internet Explorer: 9 Firefox 19 Opera: 11
Mac (PC)	Chrome: 25 Firefox: 19 Opera: 11
iOS	Chrome: 25 Safari (depends on the IOS version) Opera: 11
Android OS	Chrome: 25 Opera: 11

Note that some features might not be supported by some cellphone operating systems

### 6.1 Browsing the VP-440 Web Pages

To browse the **VP-440** Web pages:

1. Open your Internet browser.
2. Type the IP number of the device in the Address bar of your browser. For example, the default IP number:





The Input Select Web page appears.

There are eight Web pages:

- The Input Select page (see [Section 6.2](#))
- The Device Settings page (see [Section 6.3](#))
- The Output Settings page (See [Section 6.4](#))
- The HDCP page (see [Section 6.5](#))
- The EDID page (see [Section 6.6](#))
- The Audio page (see [Section 6.7](#))
- The Advanced page (see [Section 6.8](#))
- The About page (see [Section 6.9](#))

## 6.2 The Input Select Page

[Figure 13](#) shows the Input Select page that is also the first Web page. The column on the left shows the Input Select page selected and below a list of all the other available Web pages. The Input Select area lets you select an input to the outputs (audio, video or audio-follow-video) the Audio out (below Output) shows the audio input that is routed to the line and monitor outputs. The volume area lets you control the Line and Monitor output audio level. Click  to freeze the video on the output and click  to set to a blank screen.

Click the power icon on the top right side to set the device to the standby mode.

The model name, FW version and IP number appear on the lower left side of the main page. The lower part of the screen lets you save the settings and upload a saved setting.

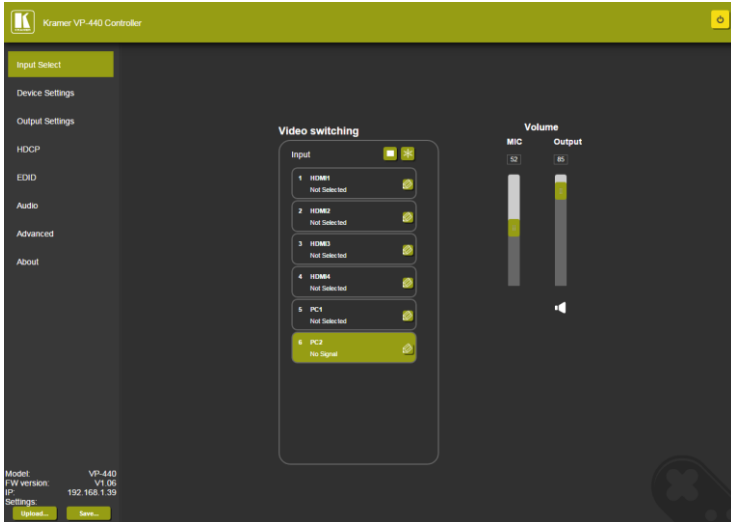

Figure 13: The Input Select Page

Click the power icon on the top right-hand side to toggle between normal operation and standby mode. When in standby mode, the icon appears dim:



Figure 14: The VP-440 Standby Mode

On the right side you can set the volume of the microphone and the output. The speaker icon (🔊) lets you mute (🔇) or unmute the audio output level.

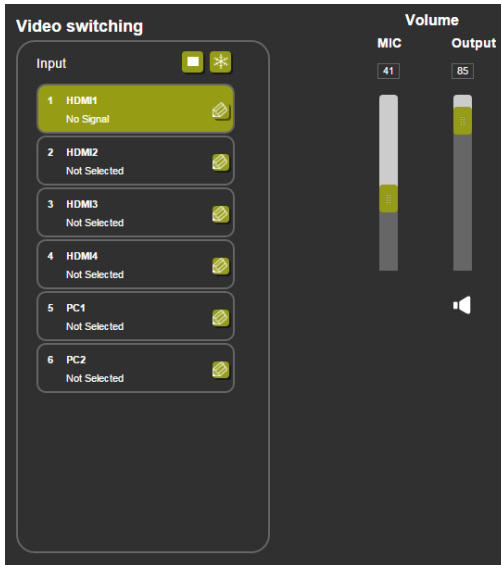

Figure 15: The Input Select Page – Mixer On/Off

To edit an input button, select that button and click the edit icon. The input edit window appears:

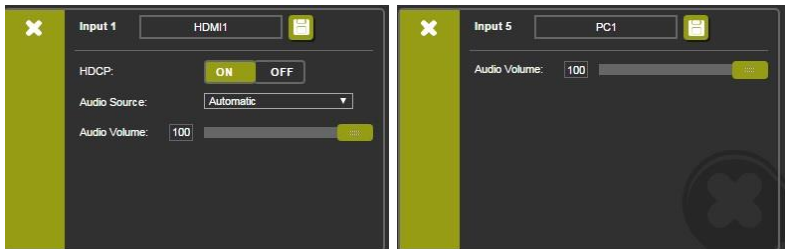

Figure 16: The Input Select Page – Edit Input Buttons (HDMI and VGA Respectively)

The input edit window lets you set the HDCP, change the name of the input as it will appear on the Web page and save it, and also set the audio source and its volume. When selecting a PC input you can change the inputs' name and set the input volume. Upon completion, save the changes (💾) and click the exit icon (X).

## 6.3 The Device Settings Page

The device Settings window ([Figure 17](#)) lets you upgrade the firmware and set the Ethernet parameters.

**Device Settings**

**Model:** VP-440  
**Name:** Kramer-00000000000000  
**MAC Address:** 00-1d-56-02-73-bb  
**Firmware Version:** V1.08  
**Firmware Update:**  No file chosen

---

DHCP On

**DHCP IP Address:**   
**Static IP Address:**   
**Gateway:**   
**Subnet:**   
**Control Port:**

---

Figure 17: The Device Settings Page

Any change in the device settings requires confirmation, as illustrated in the example in [Figure 18](#).

Are You Sure You Want To Change Static IP Setting?

Figure 18: The Device Settings Page – Static IP Confirmation

### 6.3.1 Firmware Upgrade

You can upgrade the firmware via the Device Settings page. To do so:

1. Choose the firmware file by clicking the Choose File button in the Firmware upgrade line.
2. Click the Upgrade button.

The new firmware is uploaded:

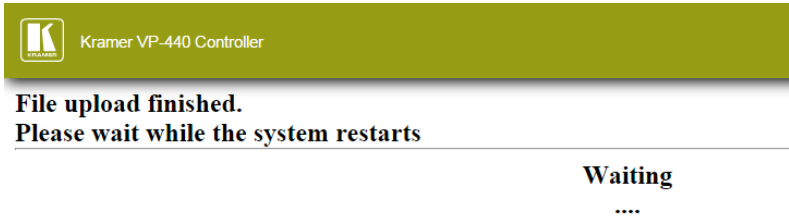

Figure 19: The Device Settings Page – Uploading the New Firmware File

3. Once the file is uploaded follow the instructions on the Web page:  
The new firmware is uploaded:



Figure 20: The Device Settings Page – Uploading the New Firmware File

4. After restarting the system you need to re-enter the IP address of the device and refresh the Web page.
5. Make sure that the new version appears on the Web page lower left side:

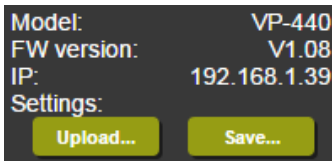

Figure 21: The Device Settings Page – New Firmware Updated

## 6.4 The Output Settings Page

Figure 22 shows the Output Settings page:

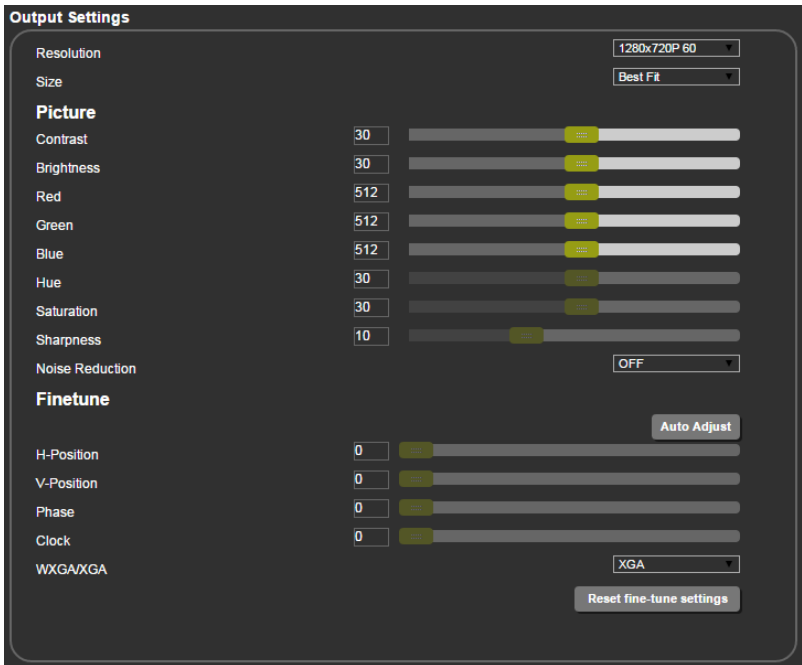

Figure 22: The Output Settings Page

The output settings, include the Resolution and Size, the picture settings, the Finetune items (enabled for VGA inputs) which can be auto adjusted or set separately, and the Finetune reset button (for resetting the finetune parameters to their default values).



## 6.5 The HDCP Page

The HDCP page lets you set the HDCP on the output (follow input or follow output) and the HDCP status for each of the HDMI inputs. [Figure 23](#) shows the HDCP page:



Figure 23: The HDCP Page

## 6.6 The EDID Page

The EDID page lets you copy a selected resolution (Native Timing) or the default resolution (HDMI or VGA) to one or more selected inputs.

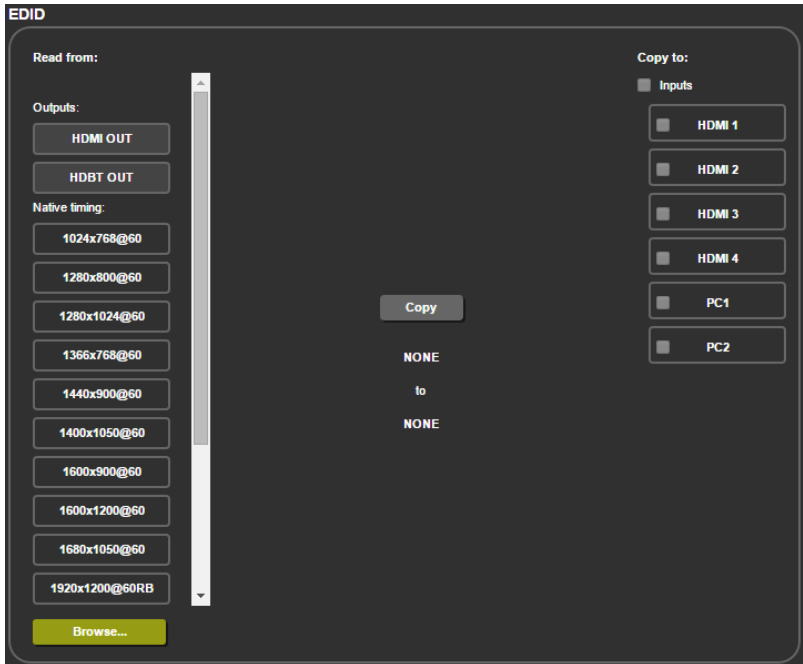

Figure 24: The EDID Page

[Figure 25](#) shows how to select a resolution from the list and select one or more inputs. To copy, click the **Copy** button:

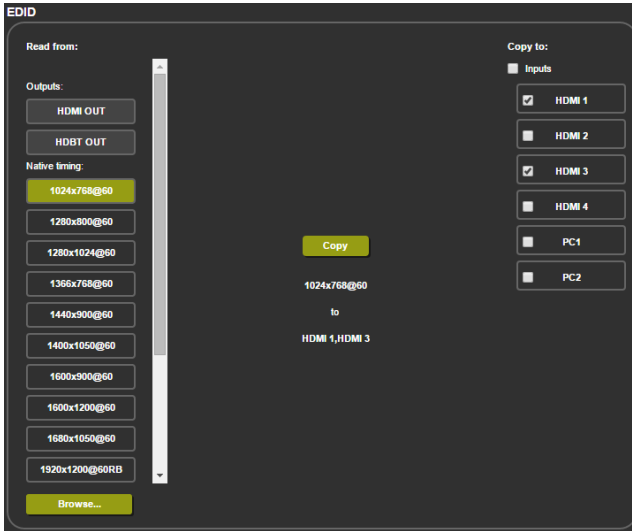

Figure 25: The EDID Page – Copying a Resolution

The EDID page displays the machine name, selected resolution, the audio channels and deep color support.

After clicking the **Copy** button, the EDID page shows the copy EDID results:

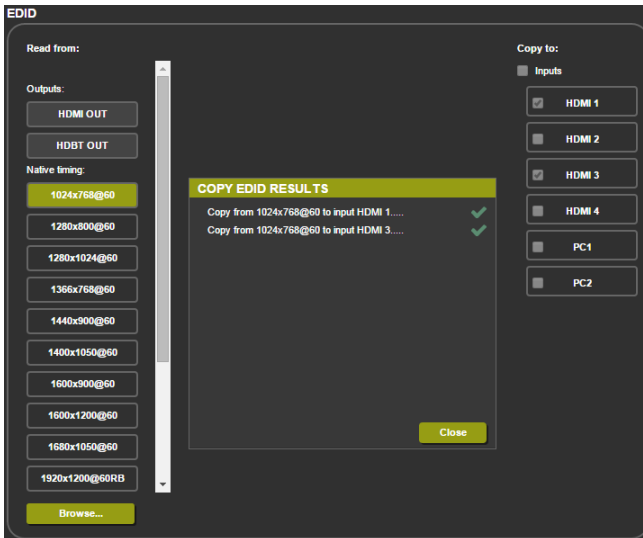

Figure 26: The EDID Page –The Copy EDID Results

Click Close to complete the EDID procedure.

## 6.7 The Audio Settings Page

The audio settings page lets you define the audio parameters for the inputs, outputs (1 and 2 together), and the microphone input (Mic), as illustrated in [Figure 27](#).

Set Mute follow freeze and Lip sync as well as the audio source (automatic, analog or embedded for the HDMI inputs) and volume level for each input. For Mic Settings, see the Main Menu in [Section 5.2.1](#).

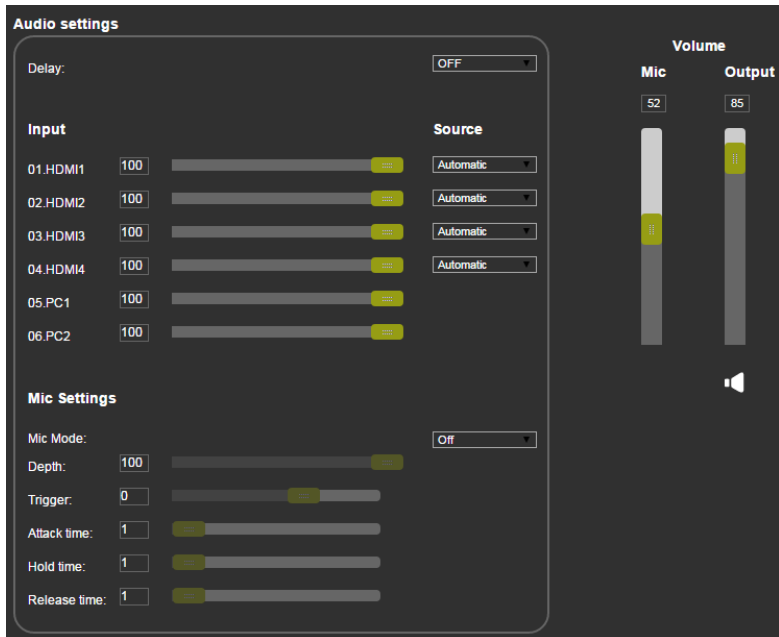

Figure 27: The Audio Settings Page

## 6.8 The Advanced Page

[Figure 28](#) shows the Advanced setting page which lets you set the auto sync off speed (either slow or fast) or disable it (Off), set the auto switching to Off, Auto Scan or Last Connected, set the input priority to PC or HDMI (once the auto scan is enabled), set the timing shift, and set the lock mode (see [Section 5.2.1](#)).

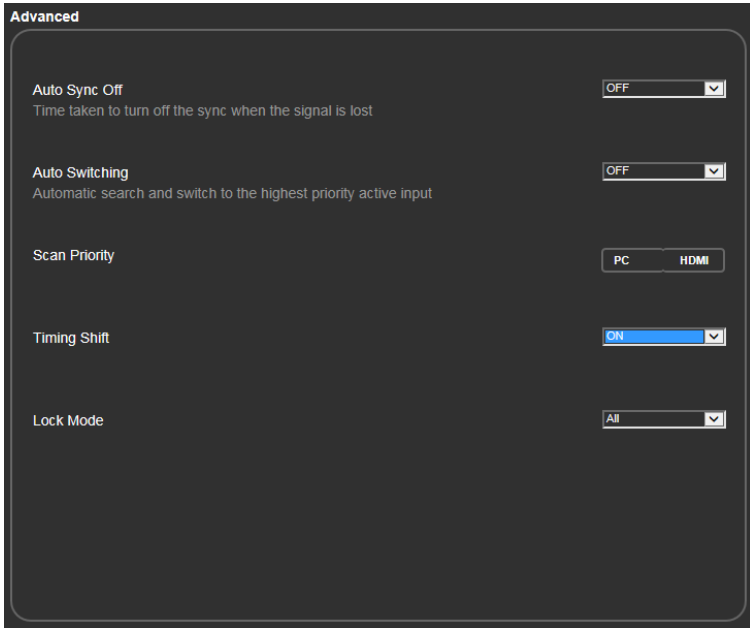

Figure 28: The Advanced Page

## 6.9 The About Page

The **VP-440** About page lets you view the Web page version and Kramer Electronics Ltd details.



Figure 29: The About Page

## 7 Technical Specifications

INPUTS:	4 HDMI connectors (HDMI, HDCP version 1.1) 2 VGA on a 15-pin HD connector 6 Unbalanced stereo audio on 3.5mm mini jack connectors 1 Mic on a 6.3mm jack connector (with selectable 48V phantom power)
OUTPUTS:	1 HDMI connector (HDMI, HDCP version 1.1) 1 HDBT on a RJ-45 connector 1 Unbalanced stereo audio on a 3.5mm mini jack connector
BANDWIDTH:	Up to 1080p, UXGA
SWITCHING TIME BETWEEN INPUTS:	2 to 3 seconds
VIDEO LATENCY:	Less than 2 frames
OUTPUT RESOLUTIONS:	Native Out 1, Native Out 2, 640x480 @60Hz, 800x600 @60Hz, 1024x768 @60Hz, 1280x768 @60Hz, 1360x768 @60Hz, 1280x720 @60Hz, 1280x800 @60Hz, 1280x1024 @60Hz, 1440x900 @60Hz, 1400x1050 @60Hz, 1680x1050 @60Hz, 1600x1200 @60Hz, 1920x1080 @60Hz, 1920x1200 @60Hz, 480p @60Hz, 720p @60Hz, 1080i @60Hz, 1080p @60Hz, 576p @50Hz, 720p @50Hz, 1080i @50Hz, 1080p @50Hz
CONTROLS	HDMI 1 to HDMI 4 and PC 1 to PC 2 input selector buttons; input select contact closure, Menu and navigation buttons, Reset to XGA/720p and panel lock buttons, RS-232 (control and data), Ethernet (OSD and Web pages)
POWER CONSUMPTION:	5V DC, 3A
OPERATING TEMPERATURE:	0° to +40°C (32° to 104°F)
STORAGE TEMPERATURE:	-40° to +70°C (-40° to 158°F)
HUMIDITY:	10% to 90%, RHL non-condensing
DIMENSIONS:	21.5cm x 16.3cm x 4.4cm (8.5" x 6.42" x 1.73"), W, D, H
WEIGHT:	1.53kg (3.37lbs) approx.
INCLUDED ACCESSORIES:	Power supply
OPTIONS:	RK-1 rack adapter, Kramer BC-HDKat6a cable
Specifications are subject to change without notice at <a href="http://www.kramerelectronics.com">http://www.kramerelectronics.com</a>	

## 7.1 Default Communication Parameters

Baud Rate:	9,600
Data Bits:	8
Stop Bits:	1
Parity:	None
To reset the IP settings to the factory reset values go to : Menu-> Factory-> RESET->Change the option to YES and press Enter	
IP Address:	192.168.1.39
Subnet mask:	255.255.0.0
Default gateway:	0.0.0.0
Default UDP Port #:	50000
Maximum UDP Ports:	4
Max. # of concurrently connected clients	1
OSD	Go to : Menu-> Factory-> RESET->Change the option to YES and press Enter
Command Format:	ASCII protocol 3000
Example (Route the video HDMI3 input to the output):	#ROUTE 12,1,2<cr>

## 7.2 Input Resolutions

Resolution/Refresh Rate	PC 1/PC 2	HDMI 1-10
640x480 (60/72/75/85Hz)	Yes	Yes
800x600 (56/60/72/75/85Hz)	Yes	Yes
1024x768 (60/70/75/85Hz)	Yes	Yes
1280x720 60Hz	Yes	Yes
1280x800 60Hz	Yes	Yes
1280x1024 (60/75/85Hz)	Yes	Yes
1366x768 60Hz	Yes	Yes
1400x1050 60Hz	Yes	Yes
1440x900 60Hz	Yes	Yes
1600x1200 60Hz	Yes	Yes
1600x900 RB 60Hz	Yes	Yes
1680x1050 RB 60Hz	Yes	Yes
1920x1080 60Hz	Yes	Yes
1920x1200 RB 60Hz	Yes	Yes
480i/576i	No	Yes
480P/576P	No	Yes
720P 50Hz	No	Yes
720P 60Hz	Yes	Yes
1080i(50/60Hz)	No	Yes
1080P(24/25/30Hz)	No	Yes
1080P 50Hz	No	Yes
1080P 60Hz	Yes	Yes

---

# 8 The RS-232/Ethernet (UDP) Communication Protocol

The **VP-440** can be operated using serial commands from a PC, remote controller, or touch screen. The unit communicates using the default Kramer Protocol 3000.

- Kramer Protocol 3000 syntax (see [Section 8.1](#))
- Kramer Protocol 3000 commands (see [Section 8.2](#))
- Kramer Protocol 3000 detailed commands (See [Section 8.3](#))

## 8.1 Kramer Protocol 3000 Syntax

Protocol 3000 communicates at a data rate of 9,600 baud, no parity, 8 data bits and 1 stop bit.

### 8.1.1 Host Message Format

Start	Address (optional)	Body	Delimiter
#	Destination_id@	Message	CR

#### Simple Command

Command string with only one command without addressing:

Start	Body	Delimiter
#	<b>Command</b> SP Parameter_1,Parameter_2,...	CR

#### Command String

Formal syntax with commands concatenation and addressing:

Start	Address	Body	Delimiter
#	Destination_id@	<b>Command_1</b> Parameter1_1,Parameter1_2,... <b>Command_2</b> Parameter2_1,Parameter2_2,... <b>Command_3</b> Parameter3_1,Parameter3_2,... ...	CR



### 8.1.2 Device Message Format

Start	Address (optional)	Body	delimiter
~	Sender_id@	Message	CR LF

### Device Long Response

Echoing command:

Start	Address (optional)	Body	Delimiter
~	Sender_id@	Command SP [Param1 ,Param2 ...] result	CR LF

**CR** = Carriage return (ASCII 13 = 0x0D)

**LF** = Line feed (ASCII 10 = 0x0A)

**SP** = Space (ASCII 32 = 0x20)

### 8.1.3 Command Terms

#### Command

A sequence of ASCII letters ('A'-'Z', 'a'-'z' and '-').

Command and parameters must be separated by at least one space.

#### Parameters

A sequence of alphanumeric ASCII characters ('0'-'9','A'-'Z','a'-'z' and some special characters for specific commands). Parameters are separated by commas.

#### Message string

Every command entered as part of a message string begins with a **message starting character** and ends with a **message closing character**.

**Note:** A string can contain more than one command. Commands are separated by a pipe ( '| ' ) character.

#### Message starting character

'#' – For host command/query

'~' – For machine response

#### Device address (Optional, for K-NET)

K-NET Device ID followed by '@'

#### Query sign

'?' follows some commands to define a query request.

### Message closing character

**CR** – For host messages; carriage return (ASCII 13)

**CRLF** – For machine messages; carriage return (ASCII 13) + line-feed (ASCII 10)

### Command chain separator character

When a message string contains more than one command, a pipe ( '| ' ) character separates each command.

Spaces between parameters or command terms are ignored.

## 8.1.4 Entering Commands

You can directly enter all commands using a terminal with ASCII communications software, such as HyperTerminal, Hercules, etc. Connect the terminal to the serial or Ethernet port on the Kramer device. To enter **CR** press the Enter key. (**LF** is also sent but is ignored by command parser).

- For commands sent from some non-Kramer controllers like Crestron, some characters require special coding (such as, /X##). Refer to the controller manual.

## 8.1.5 Command Forms

Some commands have short name syntax in addition to long name syntax to allow faster typing. The response is always in long syntax.

## 8.1.6 Command Chaining

Multiple commands can be chained in the same string. Each command is delimited by a pipe character ( '| ' ). When chaining commands, enter the **message starting character** and the **message closing character** only once, at the beginning of the string and at the end.

Commands in the string do not execute until the closing character is entered.

A separate response is sent for every command in the chain.

## 8.1.7 Maximum String Length

64 characters

## 8.2 Kramer Protocol 3000 – Command List

Command	Short Form	Description
#		Protocol handshaking
#HELP		List of commands
#BUILD-DATE?		Read device build date
#FACTORY		Reset to factory default configuration
#MODEL?		Read device model
#PROT-VER?		Read device protocol version
#SN?		Get serial number
#VERSION?		Read device firmware version
#NET-MAC?	NTMC?	Get MAC address
#NET-IP	NTIP	Set device IP address
#NET-IP?	NTIP?	Get device IP address
#NET-GATE	NTGT	Set Gateway IP
#NET-GATE?	NTGT?	Get Gateway IP
#NET-MASK	NTMSK	Set device subnet mask
#NET-MASK?	NTMSK?	Get device subnet mask
#NET-DHCP	NTDH	Set DHCP mode
#NET-DHCP?	NTDH?	Get DHCP mode
#ROUTE		Set layer routing
#ROUTE?		Get layer routing
#DISPLAY?		Get output HPD status
#LOCK-FP	LCK	Lock front panel
#LOCK-FP?	LCK?	GET Lock front panel
#HDCP-MOD		Set HDCP mode
#HDCP-MOD?		Get HDCP mode
#VID-RES		Set input/output resolution
#VID-RES?		Get input/output resolution
#VMUTE		Set enable/disable video on output
#VMUTE?		Get video on output status
#VFRZ		Set freeze video on output
#VFRZ?		Get freeze on output status
#AUD-LVL		Set audio level
#AUD-LVL?		Get audio level
#MUTE		Set audio mute
#MUTE?		Get audio mute
#SCLR-AS		Set auto-sync features
#SCLR-AS?		Get auto-sync features
#IMAGE-PROP		Set the image size
#IMAGE-PROP?		Get the image size
#SCLR-PCAUTO		Set PC auto sync of scaler
#SCLR-AUDIO-DELAY		Set the scaler audio delay
#SCLR-AUDIO-DELAY?		Get the scaler audio delay
#MIC-GAIN		Set the microphone gain

Command	Short Form	Description
#MIC-GAIN?		Get the microphone gain
#TLK		Set audio talkover mode status
#TLK?		Get audio talkover mode status
MIC-TLK		Set mic talkover parameters
MIC-TLK?		Get mic talkover parameters
#STANDBY		Set Standby mode
#STANDBY?		Get Standby mode status

## 8.3 Kramer Protocol 3000 – Detailed Commands

This section describes the detailed commands list (see [Section 8.3.3](#)) as well as the Port number key (see [Section 8.3.1](#)) and the video resolutions key (see [Section 8.3.2](#)).

### 8.3.1 Port Number Key

Video	#
HDMI 1	0
HDMI 2	1
HDMI 3	2
HDMI 4	3
PC 1	4
PC 2	5

Audio input	#
HDMI 1	0
HDMI 2	1
HDMI 3	2
HDMI 4	3
PC 1	4
PC 2	5

Video Output	#
HDMI 1	0
HDBT	1

### 8.3.2 The Output Resolutions key

Number	Resolution	Number	Resolution
200	640x480 @60Hz	212	1920x1080 @60Hz
201	800x600 @60Hz	213	1920x1200 @60Hz
202	1024x768 @60Hz	214	480p @60Hz
203	1280x768 @60Hz	215	720p @60Hz
204	1360x768 @60Hz	216	1080i @60Hz
205	1280x720 @60Hz	217	1080p @60Hz
206	1280x800 @60Hz	218	576p @50Hz
207	1280x1024 @60Hz	219	720p @50Hz
208	1440x900 @60Hz	220	1080i @50Hz
209	1400x1050 @60Hz	221	1080p @50Hz
210	1680x1050 @60Hz	222	NATIVE OUT1
211	1600x1200 @60Hz	223	NATIVE OUT2

### 8.3.3 The Commands

Command – HELP		Command Type – System-mandatory	
Command Name		Permission	Transparency
Set:	-	-	-
Get:	<b>HELP</b>	End User	-
Description		Syntax	
Set:	-	-	
Get :	Get command list or help for specific command	2 options: 1. #HELP <sub>CR</sub> 2. #HELP <sub>SP</sub> command_name <sub>CR</sub>	

Command – BUILD-DATE		Command Type – System-mandatory	
Command Name		Permission	Transparency
Set:	<b>BUILD-DATE</b>	End User	-
Get:	-	-	-
Description		Syntax	
Set:	Read device build date	#BUILD-DATE? <sub>CR</sub>	
Get :	-	-	
Response			
~nn@BUILD-DATE <sub>SP</sub> date <sub>SP</sub> time <sub>CR LF</sub>			
Parameters			
<i>date</i> – Format: YYYY/MM/DD where YYYY = Year, MM = Month, DD = Day <i>time</i> – Format: hh:mm:ss where hh = hours, mm = minutes, ss = seconds			

Command – FACTORY		Command Type – System-mandatory	
Command Name		Permission	Transparency
Set:	<b>FACTORY</b>	End User	-
Get:	-	-	-
Description		Syntax	
Set:	Reset device to factory defaults configuration	#FACTORY <sub>CR</sub>	
Get :	-	-	
Response			
~nn@FACTORY <sub>SP</sub> Ok <sub>CR LF</sub>			
Notes			
This command deletes all user data from the device. The deletion can take some time.			

Command – MODEL?		Command Type – System-mandatory	
Command Name		Permission	Transparency
Set:	-	-	-
Get:	<b>MODEL?</b>	End User	-
Description		Syntax	
Set:	-	-	
Get :	Get device model	#MODEL? <sub>CR</sub>	
Response			
~ <sub>nn</sub> @MODEL <sub>SP</sub> model_name <sub>CR LF</sub>			
Parameters			
model_name – String of up to 19 printable ASCII chars			

Command – PROT-VER?		Command Type – System-mandatory	
Command Name		Permission	Transparency
Set:	-	-	-
Get:	<b>PROT-VER?</b>	End User	-
Description		Syntax	
Set:	-	-	
Get :	Get protocol version	#PROT-VER? <sub>CR</sub>	
Response			
~ <sub>nn</sub> @PROT-VER <sub>SP</sub> 3000:version <sub>CR LF</sub>			
Parameters			
Version – Format: XX.XX where X is a decimal digit			

Command - SN?		Command Type - System-mandatory	
Command Name		Permission	Transparency
Set:	-	-	-
Get:	<b>SN?</b>	End User	Public
Description		Syntax	
Set:	-	-	
Get:	Get device serial number	#SN? <sub>CR</sub>	
Response			
~ <sub>nn</sub> @SN <sub>SP</sub> serial_number <sub>CR LF</sub>			
Parameters			
serial_number - 14 decimal digits, factory assigned			

Command – VERSION?		Command Type – System-mandatory	
Command Name		Permission	Transparency
Set:	-	-	-
Get:	<b>VERSION?</b>	End User	-
Description		Syntax	
Set:	-	-	
Get :	Get version number	#VERSION? <input type="checkbox"/> CR	
Response			
~nn@VERSION <input type="checkbox"/> SP firmware_version <input type="checkbox"/> CR LF			
Parameters			
firmware_version – Format: XX.XX.XXXX where the digits group are: major.minor.build version			

Command – NET-MAC?		Command Type – Communication	
Command Name		Permission	Transparency
Set:	-	-	-
Get:	<b>NET-MAC?</b>	End User	-
Description		Syntax	
Set:			
Get :	Get MAC address	#NET-MAC? <input type="checkbox"/> CR	
Response			
~nn@NET-MAC <input type="checkbox"/> SP mac_address <input type="checkbox"/> CR LF			
Parameters			
mac_address – Unique MAC address. Format: XX-XX-XX-XX-XX-XX where X is hex digit.			

Command – NET-IP		Command Type – Communication	
Command Name		Permission	Transparency
Set:	<b>NET-IP</b>	Administrator	-
Get:	<b>NET-IP?</b>	End User	-
Description		Syntax	
Set:	Set device IP address	#NET-IP <input type="checkbox"/> SP P1 <input type="checkbox"/> CR	
Get :	Get device IP address	#NET-IP? <input type="checkbox"/> CR	
Response			
Set: ~nn@ NET-IP <input type="checkbox"/> SP ip_address <input type="checkbox"/> SP OK <input type="checkbox"/> CR LF			
Get: ~nn@ NET-IP <input type="checkbox"/> SP ip_address <input type="checkbox"/> CR LF			
Parameters			
P1 (valid IP address)= xxx.xxx.xxx.xxx			
Notes			
For proper settings consult your network administrator.			

Command – NET-GATE		Command Type – Communication	
Command Name		Permission	Transparency
Set:	<b>NET-GATE</b>	Administrator	-
Get:	<b>NET-GATE?</b>	End User	-
Description		Syntax	
Set:	Set Gateway IP	#NET-GATE <sub>SP</sub> P1 <sub>CR</sub>	
Get :	Get Gateway IP	#NET-GATE? <sub>CR</sub>	
Response			
Set: ~nn@NET-GATE <sub>SP</sub> P1 <sub>SP</sub> OK <sub>CR LF</sub>			
Get: ~nn@NET-GATE <sub>SP</sub> ip_address <sub>CR LF</sub>			
Parameters			
P1 (valid IP address)=xxx.xxx.xxx.xxx			
Notes			
A network gateway connects the device via another network and maybe over the Internet. Be careful of security problems. For proper settings consult your network administrator			

Command – NET-MASK		Command Type – Communication	
Command Name		Permission	Transparency
Set:	<b>NET-MASK</b>	Administrator	-
Get:	<b>NET-MASK?</b>	End User	-
Description		Syntax	
Set:	Set device subnet mask	#NET-MASK <sub>SP</sub> net_mask <sub>CR</sub>	
Get :	Get device subnet mask	#NET-MASK? <sub>CR</sub>	
Response			
Set: ~nn@NET-MASK <sub>SP</sub> P1 <sub>SP</sub> OK <sub>CR LF</sub>			
Get: ~nn@NET-MASK <sub>SP</sub> net_mask <sub>CR LF</sub>			
Parameters			
P1 (valid IP address)=xxx.xxx.xxx.xxx			
Response triggers			
The subnet mask limits the Ethernet connection within the local network. For proper settings consult your network administrator.			



Command – NET-DHCP		Command Type – Communication	
Command Name		Permission	Transparency
Set:	<b>NET-DHCP</b>	Administrator	-
Get:	<b>NET-DHCP?</b>	End User	-
Description		Syntax	
Set:	Set DHCP mode	#NET-DHCP <sub>SP</sub> P1 <sub>CR</sub>	
Get :	Get DHCP mode	#NET-DHCP? <sub>CR</sub>	
Response			
Set: ~nn@ NET-DHCP <sub>SP</sub> P1 <sub>SP</sub> OK <sub>CR LF</sub>			
Get: ~nn@ NET-DHCP <sub>SP</sub> mode <sub>CR LF</sub>			
Parameters			
P1 – 0=Static IP; 1=DHCP 0 – Use static IP. 1 – Use DHCP. If unavailable, use IP as above.			
Notes			
Connecting Ethernet to devices with DHCP may take more time in some networks. To connect with a randomly assigned IP by DHCP, specify the device DNS name (if available) using the command "NAME". You can also get an assigned IP by direct connection to USB or RS-232 protocol port if available. For proper settings consult your network administrator.			

Command – ROUTE		Command Type –	
Command Name		Permission	Transparency
Set:	<b>ROUTE</b>	End User	-
Get:	<b>ROUTE?</b>	End User	-
Description		Syntax	
Set:	Set layer routing	# ROUTE <sub>SP</sub> P1,P2,P3 <sub>CR</sub>	
Get :	Get layer routing	# ROUTE? <sub>SP</sub> P1,P2 <sub>CR</sub>	
Response			
~ nn@ ROUTE <sub>SP</sub> P1,P2,P3 <sub>CR LF</sub>			
Parameters			
P1 (Layer number) –12=Video+Audio P2 – 1=Scaler P3 (Route from, valid values are in accordance to the selected layer and Route to selected according to P1 and P2) – video inputs = (0-5); see <a href="#">Section 8.3.1</a>			
Notes			
This command replaces all other routing commands.			

Command – DISPLAY?		Command Type - System	
Command Name		Permission	Transparency
Set :	-	-	-
Get	<b>DISPLAY?</b>	End User	Public
Description		Syntax	
Set:	-	-	
Get:	Get output HPD status	# <b>DISPLAY?</b> <sub>SP</sub> P1 <sub>CR</sub>	
Response			
~nn@ <b>DISPLAY</b> <sub>SP</sub> P1 <sub>CR LF</sub>			
Parameters			
P1 (Output number) – 0=HDMI; 1=HDBaseT			
Response triggers			
<ul style="list-style-type: none"> <li>After execution, response is sent to the com port from which the <b>Get</b> was received</li> <li>Response is sent after every change in output HPD status <b>ON to OFF</b></li> <li>Response is sent after every change in output HPD status <b>OFF to ON</b> and ALL parameters (new EDID, etc.) are stable and valid</li> </ul>			

Command – LOCK-FP		Command Type – System	
Command Name		Permission	Transparency
Set:	<b>LOCK-FP</b>	End User	-
Get:	<b>LOCK-FP?</b>	End User	-
Description		Syntax	
Set:	Lock front panel	# <b>LOCK-FP</b> <sub>SP</sub> P1 <sub>CR</sub>	
Get :	Get front panel lock state	# <b>LOCK-FP?</b> <sub>CR</sub>	
Response			
nn@ <b>LOCK-FP</b> <sub>SP</sub> P1 <sub>SP</sub> <b>OK</b> <sub>CR LF</sub>			
Parameters			
P1– 0=No; 1=Yes			

Command – HDCP-MOD		Command Type – System	
Command Name		Permission	Transparency
Set:	<b>HDCP-MOD</b>	Administrator	Public
Get:	<b>HDCP-MOD?</b>	End User	Public
Description		Syntax	
Set:	Set HDCP mode	# <b>HDCP-MOD</b> <input type="checkbox"/> P1,P2,P3 <input type="checkbox"/>	
Get :	Get HDCP mode	# <b>HDCP-MOD?</b> <input type="checkbox"/> P1,P2 <input type="checkbox"/>	
Response			
Set / Get : ~ <input type="checkbox"/> @ <b>HDCP-MOD</b> <input type="checkbox"/> P1,P2,P3 <input type="checkbox"/> <input type="checkbox"/>			
Parameters			
P1 (Input/Output) – 0=Input; 1=Output P2 (Scaler number) – Input 0-3=HDMI 1 – HDMI 4; Output 0-1=HDMI, HDBaseT P3 (Status) – Input: 0=Off; 1=On; Output: 2=Follow In, 3=Follow Out			
Response triggers			
<ul style="list-style-type: none"> <li>• Response is sent to the com port from which the <b>Set</b> (before execution) / <b>Get</b> command was received</li> <li>• Response is sent to all com ports after execution if HDCP-MOD was set any other external control device (button press, device menu and similar) or genlock status changed</li> </ul>			
Notes			
Set HDCP working mode <b>on device input</b> : HDCP supported – HDCP_ON [default] HDCP not supported – HDCP OFF HDCP support changes following detected sink – MIRROR OUTPUT			

Command – VID-RES		Command Type - Video	
Command Name		Permission	Transparency
Set :	<b>VID-RES</b>	End User	Public
Get	<b>VID-RES?</b>	End User	Public
Description		Syntax	
Set:	Set video resolution	# <b>VID-RES</b> <input type="checkbox"/> P1,P2,P3,P4 <input type="checkbox"/>	
Get:	Get video resolution	# <b>VID-RES?</b> <input type="checkbox"/> P1,P2,P3 <input type="checkbox"/>	
Response			
~ <input type="checkbox"/> @ <b>VID-RES</b> <input type="checkbox"/> P1,P2,P3,P4 <input type="checkbox"/> <input type="checkbox"/>			
Parameters			
P1 – 1=Output P2 – 1=Scaler P3 – 0=Off P4 - video resolutions – 200~223, see <a href="#">Section 8.3.2</a>			
Response triggers			
<ul style="list-style-type: none"> <li>• After execution, response is sent to the com port from which the <b>Set /Get</b> was received</li> <li>• After execution, response is sent to all com ports if <b>VID-RES</b> was set by any other external control device (button press, device menu and similar)</li> </ul>			

## Notes

1. "Set" command is only applicable for **stage=Output**
2. "Set" command with *is\_native=ON* sets native resolution on selected output (resolution index sent = 0). Device sends as answer actual VIC ID of native resolution
3. "Get" command with *is\_native=ON* returns native resolution VIC, with *is\_native=OFF* returns current resolution
4. To use "custom resolutions" (entries 100-105), define them using command DEF-RES

Command - VMUTE		Command Type - Video	
Command Name		Permission	Transparency
Set:	<b>VMUTE</b>	End User	Public
Get:	<b>VMUTE?</b>	End User	Public
Description		Syntax	
Set:	Set enable/disable video on output	# <b>VMUTE</b> <input type="checkbox"/> <sub>SP</sub> P1, P2 <input type="checkbox"/> <sub>CR</sub>	
Get:	Get video on output status	# <b>VMUTE?</b> <input type="checkbox"/> <sub>SP</sub> P1 <input type="checkbox"/> <sub>SP</sub> <input type="checkbox"/> <sub>CR</sub>	
Response			
Set / Get : ~ <input type="checkbox"/> <sub>nn</sub> @ <b>VMUTE</b> <input type="checkbox"/> <sub>SP</sub> P1,P2 <input type="checkbox"/> <sub>CR LF</sub>			
Parameters			
P1 (Scaler number) – 1=Scaler			
P2 (Off/On) – 0=Off; 1=On			

Command – VFRZ		Command Type – Video	
Command Name		Permission	Transparency
Set:	<b>VFRZ</b>	End User	-
Get:	<b>VFRZ?</b>	End User	-
Description		Syntax	
Set:	Set freeze video on output	# <b>VFRZ</b> <input type="checkbox"/> <sub>SP</sub> P1,P2 <input type="checkbox"/> <sub>CR</sub>	
Get :	Get freeze on output status	# <b>VFRZ?</b> <input type="checkbox"/> <sub>SP</sub> P1 <input type="checkbox"/> <sub>CR</sub>	
Response			
Set / Get : ~ <input type="checkbox"/> <sub>nn</sub> @ <b>VFRZ</b> <input type="checkbox"/> <sub>SP</sub> P1,P2 <input type="checkbox"/> <sub>CR LF</sub>			
Parameters			
P1 (Scaler number) – 1=Scaler			
P2 (Off/On) – 0=Off; 1=On			

Command – AUD-LVL		Command Type – Audio	
Command Name		Permission	Transparency
Set:	<b>AUD-LVL</b>	End User	-
Get:	<b>AUD-LVL?</b>	End User	-
Description		Syntax	
Set:	Set audio level in specific amplifier stage	#AUD-LVL <sub>SP</sub> P1,P2,P3 <sub>CR</sub>	
Get :	Get audio level in specific amplifier stage	#AUD-LVL? <sub>SP</sub> P1,P2 <sub>CR</sub>	
Response			
~nn@AUD-LVL <sub>SP</sub> P1,P2 <sub>CR LF</sub>			
Parameters			
P1 (Input/Output)– 0=Input; 1=Output P2 (Input/Output number valid according to the selected Input/Output according to P1) – audio inputs=0–5; Audio outputs=0; (see <a href="#">Section 8.3.1</a> ) P3 – 0~100; minus sign precedes negative values. ++ increase current value, -- decrease current value			

Command - MUTE		Command Type - Audio	
Command Name		Permission	Transparency
Set:	<b>MUTE</b>	End User	Public
Get:	<b>MUTE?</b>	End User	Public
Description		Syntax	
Set:	Set audio mute	#MUTE <sub>SP</sub> channel,mute_mode <sub>CR</sub>	
Get:	Get audio mute	#MUTE? <sub>SP</sub> channel <sub>CR</sub>	
Response			
~nn@MUTE <sub>SP</sub> channel, mute_mode <sub>CR LF</sub>			
Parameters			
channel – Scaler=1 mute_mode - 0=Off; 1=ON			

Command – Scaler As?		Command Type – [Audio]	
Command Name		Permission	Transparency
Set:	<b>SCLR-AS</b>	End User	Public
Get:	<b>SCLR-AS?</b>	End User	Public
Description		Syntax	
Set:	Set the auto sync off timer	# SCLR-AS <sub>SP</sub> P1,P2 <sub>CR</sub>	
Get :	Get the auto sync off timer definition	# SCLR-AS? <sub>SP</sub> P1 <sub>CR</sub>	
Response			
Set / Get : ~ nn@ SCLR-AS <sub>SP</sub> P1,P2.... <sub>CR LF</sub>			

<b>Parameters</b>
P1 (Scaler Number) –1=Scaler P2 (Off/On) – 0=Off; 1=Fast; 2=Slow
<b>Response triggers</b>
Response is sent to the com port from which the <b>Set</b> (before execution) / <b>Get</b> command was received After execution, response is sent to all com ports if CMD-NAME was set any other external control device (button press, device menu and similar) or genlock status was changed
<b>Notes</b>
Sets the Auto Sync features for the selected Scaler

<b>Command – Image Proportions</b>		Command Type – [Video]	
<b>Command Name</b>		<b>Permission</b>	<b>Transparency</b>
Set:	<b>IMAGE-PROP</b>	End User	Public
Get:	<b>IMAGE-PROP?</b>	End User	Public
<b>Description</b>		<b>Syntax</b>	
Set:	Set the image size	# <b>IMAGE-PROP</b> <input type="checkbox"/> <sub>SP</sub> P1 <input type="checkbox"/> <sub>CR</sub>	
Get :	Get the image size	# <b>IMAGE-PROP?</b> <input type="checkbox"/> <sub>SP</sub> P1,...,P6 <input type="checkbox"/> <sub>CR</sub>	
<b>Response</b>			
Set / Get : ~ <input type="checkbox"/> <sub>nn</sub> @ <b>IMAGE-PROP</b> <input type="checkbox"/> <sub>SP</sub> P1,P2... <input type="checkbox"/> <sub>CR LF</sub>			
<b>Parameters</b>			
P1 (Scaler number) – 1=Scaler P2 (Status) – 0=Over Scan; 1=Full; 2=Best Fit; 3=PanScan; 4=Letter Box; 5=Under 2; 6=Under 1			
<b>Response triggers</b>			
Response is sent to the com port from which the <b>Set</b> (before execution) / <b>Get</b> command was received After execution, response is sent to all com ports if CMD-NAME was set any other external control device (button press, device menu and similar) or genlock status was changed			
<b>Notes</b>			
Sets the image properties of the selected scaler			

<b>Command – PC Auto Sync</b>		Command Type – [Video]	
<b>Command Name</b>		<b>Permission</b>	<b>Transparency</b>
Set:	<b>SCLR-PCAUTO</b>	End User	Public
Get:		End User	Public
<b>Description</b>		<b>Syntax</b>	
Set:	Set PC auto sync of scaler	# <b>SCLR-PCAUTO</b> <input type="checkbox"/> <sub>SP</sub> P1,P2 <input type="checkbox"/> <sub>CR</sub>	
Get :			
<b>Response</b>			
Set / Get : ~ <input type="checkbox"/> <sub>nn</sub> @ <b>SCLR-PCAUTO</b> <input type="checkbox"/> <sub>SP</sub> P1,P2... <input type="checkbox"/> <sub>CR LF</sub>			
<b>Parameters</b>			
P1 (Scaler number) –1=Scaler P2 (Off/On) –1=Yes			

<b>Response triggers</b>
Response is sent to the com port from which the Set (before execution) / Get command was received After execution, response is sent to all com ports if CMD-NAME was set any other external control device (button press, device menu and similar) or genlock status was changed
<b>Notes</b>
Sets the PC Auto sync of the selected scaler

<b>Command – Scaler Audio Delay</b>		<b>Command Type – [Audio]</b>	
<b>Command Name</b>		<b>Permission</b>	<b>Transparency</b>
Set:	<b>SCLR-AUDIO-DELAY</b>	End User	Public
Get:	<b>SCLR-AUDIO-DELAY?</b>	End User	Public
<b>Description</b>		<b>Syntax</b>	
Set:	Set the scaler audio delay	# <b>SCLR-AUDIO-DELAY</b> <input type="checkbox"/> <sub>SP</sub> P1,P2 <input type="checkbox"/> <sub>CR</sub>	
Get :	Get the scaler audio delay	# <b>SCLR-AUDIO-DELAY?</b> <input type="checkbox"/> <sub>SP</sub> P1 <input type="checkbox"/> <sub>CR</sub>	

<b>Response</b>
Set / Get : ~ <input type="checkbox"/> @ <b>SCLR-AUDIO-DELAY</b> <input type="checkbox"/> <sub>SP</sub> P1,P2 <input type="checkbox"/> <sub>CR LF</sub>
<b>Parameters</b>
P1 (Audio output number) – 1=Scaler P2 (Level selection) – 0=Off; 1=40ms; 2=110ms; 3=150ms

<b>Response triggers</b>
Response is sent to the com port from which the Set (before execution) / Get command was received After execution, response is sent to all com ports if CMD-NAME was set any other external control device (button press, device menu and similar) or genlock status was changed
<b>Notes</b>
Sets the audio delay for the selected audio output

<b>Command – Microphone Gain</b>		<b>Command Type – [Audio]</b>	
<b>Command Name</b>		<b>Permission</b>	<b>Transparency</b>
Set:	<b>MIC-GAIN</b>	End User	Public
Get:	<b>MIC-GAIN?</b>	End User	Public
<b>Description</b>		<b>Syntax</b>	
Set:	Set the microphone gain	# <b>MIC-GAIN</b> <input type="checkbox"/> <sub>SP</sub> P1,P2,P3 <input type="checkbox"/> <sub>CR</sub>	
Get :	Get the microphone gain	# <b>MIC-GAIN?</b> <input type="checkbox"/> <sub>SP</sub> P1 <input type="checkbox"/> <sub>CR</sub>	

<b>Response</b>
Set / Get : ~ <input type="checkbox"/> @ <b>MIC-GAIN</b> <input type="checkbox"/> <sub>SP</sub> P1,P2, <input type="checkbox"/> <sub>CR LF</sub>
<b>Parameters</b>
P1 (always 0) – 0 P2 - 0=Mic P3 (level) – 0 to 100

## Response Triggers

Response is sent to the com port from which the Set (before execution) / Get command was received  
After execution, response is sent to all com ports if CMD-NAME was set any other external control device (button press, device menu and similar) or genlock status was changed

### Notes

Sets the Microphone input audio gain

Command - TLK		Command Type - Audio	
Command Name		Permission	Transparency
Set:	<b>TLK</b>	End User	Public
Get:	<b>TLK?</b>	End User	Public
Description		Syntax	
Set:	Set audio talkover mode status	# <b>TLK</b> <sub>SP</sub> channel,talkover_mode <sub>CR</sub>	
Get:	Get audio talkover mode status	# <b>TLK?</b> channel, <sub>CR</sub>	
Response			
~nn@ <b>TLK</b> <sub>SP</sub> channel,talkover_mode <sub>CR LF</sub>			
Parameters			
channel - output number talkover_mode - 0=OFF; 1=Mixer; 2=Talkover; 3=Mic only			

Command - MIC-TLK		Command Type - Audio	
Command Name		Permission	Transparency
Set:	<b>MIC-TLK</b>	End User	Public
Get:	<b>MIC-TLK?</b>	End User	Public
Description		Syntax	
Set:	Set mic talkover parameters	# <b>MIC-TLK</b> <sub>SP</sub> channel,P1,value <sub>CR</sub>	
Get:	Get mic talkover parameters	# <b>MIC-TLK?</b> <sub>SP</sub> channel,P1 <sub>CR</sub>	
Response			
~nn@ <b>MIC-TLK</b> <sub>SP</sub> channel,P1,value <sub>CR LF</sub>			
Parameters			
P1 (channel) - 0 P2 (parameter setting) - 0=Depth, 1=Trigger, 2=Attack time, 3=Hold time, 4=Release time P3 (value) - P1 value (in corresponding to P1 units): Depth: 0~100 [%], Trigger: 0~100 (-60dB~40dB), Attack/Hold/Release time: 0~200 (0~2 sec)			



Command – STANDBY		Command Type – [Audio]	
Command Name		Permission	Transparency
Set:	<b>STANDBY</b>	End User	Public
Get:	<b>STANDBY?</b>	End User	Public
Description		Syntax	
Set:	Set Standby mode	# <b>STANDBY</b> <input type="checkbox"/> <i>on_off</i> <input type="checkbox"/>	
Get :	Get Standby mode status	# <b>STANDBY?</b> <input type="checkbox"/>	
Response			
~ <input type="checkbox"/> @ <b>STANDBY</b> <input type="checkbox"/> <i>value</i> <input type="checkbox"/> <i>CR LF</i>			
Parameters			
on_off – 0=Off; 1=On			

## LIMITED WARRANTY

The warranty obligations of Kramer Electronics for this product are limited to the terms set forth below:

### What is Covered

This limited warranty covers defects in materials and workmanship in this product.

### What is Not Covered

This limited warranty does not cover any damage, deterioration or malfunction resulting from any alteration, modification, improper or unreasonable use or maintenance, misuse, abuse, accident, neglect, exposure to excess moisture, fire, improper packing and shipping (such claims must be presented to the carrier), lightning, power surges, or other acts of nature. This limited warranty does not cover any damage, deterioration or malfunction resulting from the installation or removal of this product from any installation, any unauthorized tampering with this product, any repairs attempted by anyone unauthorized by Kramer Electronics to make such repairs, or any other cause which does not relate directly to a defect in materials and/or workmanship of this product. This limited warranty does not cover cartons, equipment enclosures, cables or accessories used in conjunction with this product.

Without limiting any other exclusion herein, Kramer Electronics does not warrant that the product covered hereby, including, without limitation, the technology and/or integrated circuit(s) included in the product, will not become obsolete or that such items are or will remain compatible with any other product or technology with which the product may be used.

### How Long Does this Coverage Last

Seven years as of this printing; please check our Web site for the most current and accurate warranty information.

### Who is Covered

Only the original purchaser of this product is covered under this limited warranty. This limited warranty is not transferable to subsequent purchasers or owners of this product.

### What Kramer Electronics will do

Kramer Electronics will, at its sole option, provide one of the following three remedies to whatever extent it shall deem necessary to satisfy a proper claim under this limited warranty:

1. Elect to repair or facilitate the repair of any defective parts within a reasonable period of time, free of any charge for the necessary parts and labor to complete the repair and restore this product to its proper operating condition. Kramer Electronics will also pay the shipping costs necessary to return this product once the repair is complete.
2. Replace this product with a direct replacement or with a similar product deemed by Kramer Electronics to perform substantially the same function as the original product.
3. Issue a refund of the original purchase price less depreciation to be determined based on the age of the product at the time remedy is sought under this limited warranty.

### What Kramer Electronics will not do Under This Limited Warranty

If this product is returned to Kramer Electronics or the authorized dealer from which it was purchased or any other party authorized to repair Kramer Electronics products, this product must be insured during shipment, with the insurance and shipping charges prepaid by you. If this product is returned uninsured, you assume all risks of loss or damage during shipment. Kramer Electronics will not be responsible for any costs related to the removal or re-installation of this product from or into any installation. Kramer Electronics will not be responsible for any costs related to any setting up this product, any adjustment of user controls or any programming required for a specific installation of this product.

### How to Obtain a Remedy under this Limited Warranty

To obtain a remedy under this limited warranty, you must contact either the authorized Kramer Electronics reseller from whom you purchased this product or the Kramer Electronics office nearest you. For a list of authorized Kramer Electronics resellers and/or Kramer Electronics authorized service providers, please visit our web site at [www.kramerelectronics.com](http://www.kramerelectronics.com) or contact the Kramer Electronics office nearest you.

In order to pursue any remedy under this limited warranty, you must possess an original, dated receipt as proof of purchase from an authorized Kramer Electronics reseller. If this product is returned under this limited warranty, a return authorization number, obtained from Kramer Electronics, will be required. You may also be directed to an authorized reseller or a person authorized by Kramer Electronics to repair the product.

If it is decided that this product should be returned directly to Kramer Electronics, this product should be properly packed, preferably in the original carton, for shipping. Cartons not bearing a return authorization number will be refused.

### Limitation on Liability

THE MAXIMUM LIABILITY OF KRAMER ELECTRONICS UNDER THIS LIMITED WARRANTY SHALL NOT EXCEED THE ACTUAL PURCHASE PRICE PAID FOR THE PRODUCT. TO THE MAXIMUM EXTENT PERMITTED BY LAW, KRAMER ELECTRONICS IS NOT RESPONSIBLE FOR DIRECT, SPECIAL, INCIDENTAL OR CONSEQUENTIAL DAMAGES RESULTING FROM ANY BREACH OF WARRANTY OR CONDITION, OR UNDER ANY OTHER LEGAL THEORY. Some countries, districts or states do not allow the exclusion or limitation of relief, special, incidental, consequential or indirect damages, or the limitation of liability to specified amounts, so the above limitations or exclusions may not apply to you.

### Exclusive Remedy

TO THE MAXIMUM EXTENT PERMITTED BY LAW, THIS LIMITED WARRANTY AND THE REMEDIES SET FORTH ABOVE ARE EXCLUSIVE AND IN LIEU OF ALL OTHER WARRANTIES, REMEDIES AND CONDITIONS, WHETHER ORAL OR WRITTEN, EXPRESS OR IMPLIED. TO THE MAXIMUM EXTENT PERMITTED BY LAW, KRAMER ELECTRONICS SPECIFICALLY DISCLAIMS ANY AND ALL IMPLIED WARRANTIES, INCLUDING, WITHOUT LIMITATION, WARRANTIES OF MERCHANTABILITY AND FITNESS FOR A PARTICULAR PURPOSE. IF KRAMER ELECTRONICS CANNOT LAWFULLY DISCLAIM OR EXCLUDE IMPLIED WARRANTIES UNDER APPLICABLE LAW, THEN ALL IMPLIED WARRANTIES COVERING THIS PRODUCT, INCLUDING WARRANTIES OF MERCHANTABILITY AND FITNESS FOR A PARTICULAR PURPOSE, SHALL APPLY TO THIS PRODUCT AS PROVIDED UNDER APPLICABLE LAW.

IF ANY PRODUCT TO WHICH THIS LIMITED WARRANTY APPLIES IS A "CONSUMER PRODUCT" UNDER THE MAGNUSON-MOSS WARRANTY ACT (15 U.S.C.A. §2301, ET SEQ.) OR OTHER APPLICABLE LAW, THE FOREGOING DISCLAIMER OF IMPLIED WARRANTIES SHALL NOT APPLY TO YOU, AND ALL IMPLIED WARRANTIES ON THIS PRODUCT, INCLUDING WARRANTIES OF MERCHANTABILITY AND FITNESS FOR THE PARTICULAR PURPOSE, SHALL APPLY AS PROVIDED UNDER APPLICABLE LAW.

### Other Conditions

This limited warranty gives you specific legal rights, and you may have other rights which vary from country to country or state to state.

This limited warranty is void if (i) the label bearing the serial number of this product has been removed or defaced, (ii) the product is not distributed by Kramer Electronics or (iii) this product is not purchased from an authorized Kramer Electronics reseller. If you are unsure whether a reseller is an authorized Kramer Electronics reseller, please visit our Web site at [www.kramerelectronics.com](http://www.kramerelectronics.com) or contact a Kramer Electronics office from the list at the end of this document.

Your rights under this limited warranty are not diminished if you do not complete and return the product registration form or complete and submit the online product registration form. Kramer Electronics thanks you for purchasing a Kramer Electronics product. We hope it will give you years of satisfaction.

# KRAMER



## SAFETY WARNING

Disconnect the unit from the power supply before opening and servicing

For the latest information on our products and a list of Kramer distributors, visit our Web site where updates to this user manual may be found.

We welcome your questions, comments, and feedback.

[www.kramerAV.com](http://www.kramerAV.com)  
[info@kramerel.com](mailto:info@kramerel.com)